

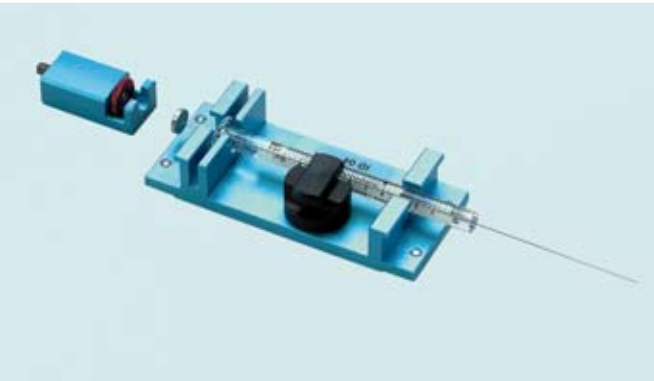

Prep and Load Platform

Accessories

GC



PAL and PAL-*xt* product line
accessory catalogue 2010 / 2011

Syringe Kits	3
Syringes and Syringe Plungers	4 - 5
Trays, Traysets and Stacks	5 - 6
Thermostatted Trayholders	6 - 7
PAL Dilutor	8
FlowCell, Washstations and Consumables	9 - 10
SPME Options	10
ITEX-2, Headspace and <i>xt</i>- Upgrade Kits	11
GC Mounting Kits and MHE Tool	12
PAL Exchange Option	12
Barcode Reader	13
Software, IQ/OQ Protocols and Tools	13

Important notice:

If not specifically mentioned all options and accessories are also available for previous PAL COMBI and PAL GC

PALBrochCat2010-11

CTC Analytics does not supply sample vials, caps and seals for PAL Systems. CTC refers to the following companies, who distribute certified and approved PAL consumables. The local distributors can be found on the corresponding websites.

Worldwide

La-Pha-Pack® GmbH

Am Parir 20
D-52379 Langerwehe
Germany

Tel: +49 24239431-0
Fax: +49 24239431-33
Email: service@la-pha-pack.com
Web: www.la-pha-pack.com

Chromacol Ltd

3 Mundells Industrial Centre
Welwyn Garden City
Herts, AL7 1EW,
United Kingdom

Tel: +44 1707 394949
Fax: +44 1707 391311
Email: enquiries@chromacol.com
Web: www.chromacol.com

North America only

Microliter Analytical Supplies

P.O. Box 808
3680 Burnette Park Dr. Suite# C
Suwanee, GA 30024
USA

Tel: 1-888-232-7840
Fax: 770-932-6652
Email: microliter@aol.com
Web: www.microliter.com

CTC Analytics

Where design meets performance

CTC Analytics AG
Switzerland
info@ctc.ch
www.palsystem.com

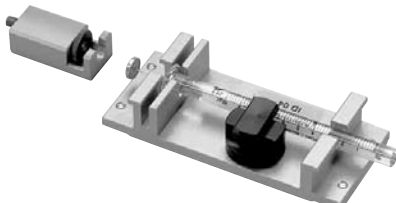
PAL Accessory	Part Number	Description	Combi-xt	GC-xt
Syringe Kits Liquid Version 	PAL SyrGC1.2µl	Kit GC Syringe 1.2µl for PAL Combi- xt or PAL GC- xt 1 pc syringe adapter and plunger holder 2 pcs syringe SYRC L1.2-26P-AS (plunger in needle design, needle OD 0.50 mm)	●	●
	PAL SyrGC5µl	Kit GC Syringe 5µl for PAL Combi- xt or PAL GC- xt 1 pc syringe adapter and plunger holder 2 pcs syringe SYRC L5-26S-AS	●	●
	PAL SyrGC10µl	Kit GC Syringe 10µl for PAL Combi- xt or PAL GC- xt 1 pc syringe adapter and plunger holder 2 pcs syringe SYRC L10-26S-AS	●	●
	PAL SyrGC10µl-G	Kit GC Syringe 10µl for PAL Combi- xt or PAL GC- xt 1 pc syringe adapter and plunger holder 2 pcs syringe SYRC G10-26S-AS	●	●
	PAL SyrGC25µl	Kit GC Syringe 25µl for PAL Combi- xt or PAL GC- xt 1 pc syringe adapter and plunger holder 2 pcs syringe SYRC G25-26S-AS	●	●
	PAL SyrGC100µl	Kit GC Syringe 100µl for PAL Combi- xt or PAL GC- xt 1 pc syringe adapter and plunger holder 2 pcs syringe SYRC G100-26S-AS	●	●
	PAL SyrGC250µl	Kit GC Syringe 250µl for PAL Combi- xt or PAL GC- xt 1 pc syringe adapter and plunger holder 2 pcs syringe SYRC G250-26-AS	●	●
	PAL SyrGC500µl	Kit GC Syringe 500µl for PAL Combi- xt or PAL GC- xt 1 pc syringe adapter and plunger holder 2 pcs Syringe SYRC G500-26-AS	●	●

Syringe Kits Headspace Version





PAL SyrHS1.0ml	Kit HS Syringe 1.0ml for PAL Combi- xt 1 pc syringe heater 1 pc plunger holder 2 pcs syringe SYRC HS1.0-23-5	●	○
PAL SyrHS2.5ml	Kit HS Syringe 2.5ml for PAL Combi- xt 1 pc syringe heater 1 pc plunger holder 2 pcs syringe SYRC HS2.5-23-5	●	○
PAL SyrHS5.0ml	Kit HS Syringe 5.0ml for PAL Combi- xt 1 pc syringe heater 1 pc plunger holder 2 pcs syringe SYRC HS5.0-23-5	●	○

PAL Accessory	Part Number	Description	Combi-xt	GC-xt
	SYRC L1.2-26P-AS	Liquid syringe 1.2µl for PAL Combi- xt or PAL GC- xt fixed needle gauge 26P, pointstyle AS	●	●
	SYRC L5-26S-AS	Liquid syringe 5µl for PAL Combi- xt or PAL GC- xt fixed needle gauge 26S, pointstyle AS	●	●
	SYRC L10-26S-AS	Liquid syringe 10µl for PAL Combi- xt or PAL GC- xt fixed needle gauge 26S, pointstyle AS	●	●
	SYRC L10-26S-2	Liquid syringe 10µl for PAL Combi- xt or PAL GC- xt fixed needle gauge 26S, pointstyle 2	●	●
	SYRC G10-26S-AS	Liquid syringe 10µl for PAL Combi- xt or PAL GC- xt fixed needle gauge 26S, pointstyle AS	●	●
	SYRC L10-23S-AS	Liquid syringe 10µl for PAL Combi- xt or PAL GC- xt fixed needle gauge 23S, pointstyle AS	●	●
	SYRC G25-26S-AS	Liquid syringe 25µl for PAL Combi- xt or PAL GC- xt fixed needle gauge 26S, pointstyle AS	●	●
	SYRC G100-26S-AS	Liquid syringe 100µl for PAL Combi- xt or PAL GC- xt fixed needle gauge 26S, pointstyle AS	●	●
	SYRC G250-26-AS	Liquid syringe 250µl for PAL Combi- xt or PAL GC- xt fixed needle gauge 26, pointstyle AS	●	●
	SYRC G500-26-AS	Liquid syringe 500µl for PAL Combi- xt or PAL GC- xt fixed needle gauge 26, pointstyle AS	●	●
	SYRSGE L10-23S-AS	Liquid syringe SGE 10 µl, 0.63 OD, Gauge 23, diameter 6.5, fixed needle – 50mm cone tip dark orange coloured	●	●
	SYRSGE L10-26S-2	Liquid syringe SGE 10 µl, 0.47 OD, Gauge 26 diameter 6.5, fixed needle – 50mm bevel tip dark orange coloured	●	●
	SYRSGE L10-26S-AS	Liquid syringe SGE 10 µl, 0.47 OD, Gauge 26 diameter 6.5, Fixed needle – 50mm cone tip dark orange coloured	●	●

Syringes Headspace Version

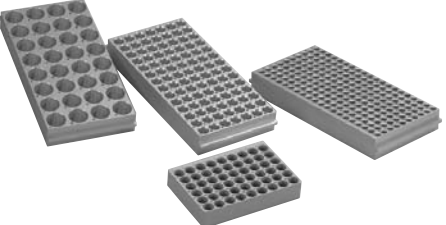

SYRC HS1.0-23-5	Headspace Syringe HD -type 1.0ml for PAL Combi- xt fixed sideport needle gauge 23, pointstyle 5	●	○
SYRC HS2.5-23-5	Headspace Syringe HD -type 2.5ml for PAL Combi- xt fixed sideport needle gauge 23, pointstyle 5	●	○
SYRC HS5.0-23-5	Headspace Syringe HD -type 5.0ml for PAL Combi- xt fixed sideport needle gauge 23, pointstyle 5	●	○

PAL Accessory	Part Number	Description	Combi-xt	GC-xt
Replacement Plungers 	PLG G10	10 pcs replacement plunger for 10µl syringe	●	●
	PLG G25	10 pcs replacement plunger for 25µl syringe	●	●
	PLG G100	10 pcs replacement plunger for 100µl syringe	●	●
	PLG G250	10 pcs replacement plunger for 250µl syringe	●	●
	PLG G500	10 pcs replacement plunger for 500µl syringe	●	●
	PLG HD1000	1 pc HD -type replacement plunger for 1000µl headspace syringe	●	○
	PLG HD2500	1 pc HD -type replacement plunger for 2500µl headspace syringe	●	○
	PLG HD5000	1 pc HD -type replacement plunger for 5000µl headspace syringe	●	○
Trays 	PAL Tray1ml	Sample tray for 200 vials 0.7/1ml	●	●
	PAL Tray2ml	Sample tray for 98 vials 2ml or 78 vials 0.7/1ml	●	●
	PAL Tray20ml	Sample tray for 32 vials 10/20ml or 21 vials 2ml	●	●
	PAL TrayMT2ml	Sample tray for PAL Stack4DW deepwell stack 54 x 2ml vials (up to 4 trays may be used in 1 PAL Stack4DW)	●	●
	PAL TrayMT2ml/6	Set of 6 pcs PAL TrayMT2ml sample trays	●	●
	Traysets 	PAL TraySet1ml	Sample tray for 200 vials 0.7/1ml, including trayholder 76mm	●
PAL TraySet2ml		Sample tray for 98 vials 2ml or 78 vials 0.7/1ml, including trayholder 76mm	●	●
PAL TraySet10ml		Sample tray for 32 vials 10ml or 21 vials 2ml, including trayholder 76mm (can not be used for 20ml vials)	●	●
PAL TraySet20ml		Sample tray for 32 vials 10/20ml or 21 vials 2ml, including trayholder holder 114mm (positioned 38mm lower than standard holder)	●	●
PAL TraySet2ml-2		Sample tray for 98 vials 2ml or 78 vials 0.7/1ml, including trayholder 114mm (holder may be alternatively used for 20ml vial trays)	●	●

PAL Accessory	Part Number	Description	Combi-xt	GC-xt
---------------	-------------	-------------	----------	-------

Trayset MT



PAL MTHolder

Trayholder 76mm for
2 microtiter/deepwell plates (96/384 wells) or
2 PAL TrayMT2ml

• •

PAL Stack, GC Version

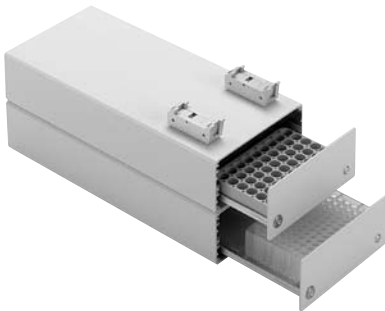

PAL Stk4DW

PAL System stack for
4 deepwell- or microplates (96/384 wells) or
4 PAL TrayMT2ml

• •

Stack Cooler 2DW (Peltier Version)

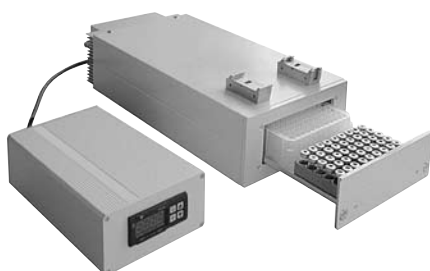

PAL StkCooler2DW

Peltier cooled 2DW Stack 4°C to 40°C for
2 deepwell- or microplates (96/384 wells) or
2 PAL TrayMT2ml
including 1 pc power supply 110V/240V
LED display, temperature regulation $\pm 1^\circ\text{C}$

• •

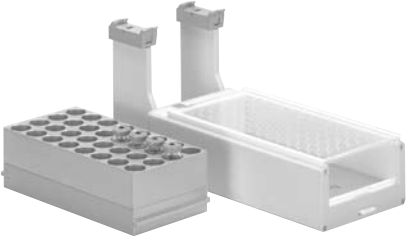
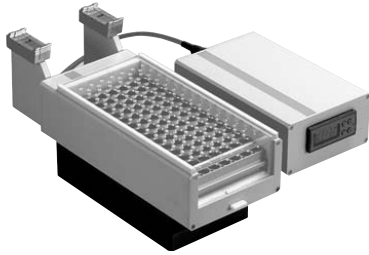
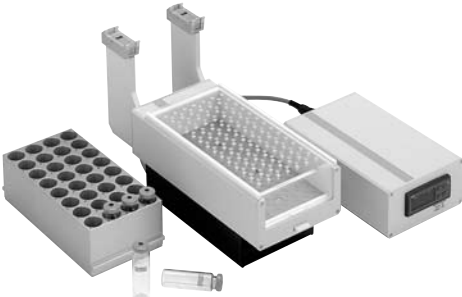

PAL Accessory	Part Number	Description	Combi-xt	GC-xt
Tray Cooler (Liquid Version) 	PAL LiqCooler	Liquid Tray Cooler 4°C to 70°C* for: 1 PAL Tray2ml or 1 PAL Tray1ml or 1 microtiter- or deepwell plate (96 wells) 1 pc plastic tray cover for PAL Tray2ml (*excluding sample tray and external circulator)	•	•
	MC 30-10	Cooler plastic tray cover for PAL Tray1ml	•	•
	MC 30-11	Cooler plastic tray cover for PAL Tray2ml	•	•
	MC 30-14	Cooler plastic tray cover for 96 well MT/DW	•	•
	MC 50-01	Adapter plate for 196 well MT/DW	•	•
Tray Cooler2 (Liquid Version) 	PAL LiqCooler2	Liquid Tray Cooler 4°C to 70°C* consisting of: 1 pc liquid tray cooler with 136mm leg 1 pc cooling plate for 32 20ml vials 1 pc plastic tray cover for PAL Tray2ml (*excluding external circulator)	•	•
	MP 50-031	Cooling plate for 32 vials 10/20ml (requires PAL LiqCooler2)	•	•
Tray Cooler (Peltier Version) 	PAL TrayCooler	Peltier Cooler 4°C to 70°C* for 1 PAL Tray2ml or 1 PAL Tray1ml or 1 microtiter- or deepwell plate (96 wells) including 1 plastic tray cover for PAL Tray2ml and power supply 110V/220V LED display, temperature regulation ± 1°C (* sample tray not included)	•	•
	MC 30-10	Cooler plastic tray cover for PAL Tray1ml	•	•
	MC 30-11	Cooler plastic tray cover for PAL Tray2ml	•	•
	MC 30-14	Cooler plastic tray cover for 96 well MT/DW	•	•
Tray Cooler2 (Peltier Version) 	PAL TrayCooler2	Peltier Cooler 4°C to 70°C* consisting of: 1 pc tray cooler with 136mm legs 1 pc cooling plate for 32 20ml vials 1 pc plastic tray cover for PAL Tray2ml and power supply 110V/220V LED display, temperature regulation ± 1°C	•	•
	MP 50-031	Cooling plate for 32 20ml vials (requires PAL Tray Cooler2)	•	•





PAL Accessory	Part Number	Description	Combi-xt	GC-xt
	PAL Dilutor	PAL Dilutor Option consisting of: 1 pc Dilutor module 1 pc Dilutor syringe 2.5ml 1 pc solvent bottle transfer line including filter 1 pc solvent bottle 1000ml with cap 1 pc transfer tubing kit 1/16" 1 pc Dilutor module connection cable 1 pc operating manual (requires PAL SyrGCSP80µl, PAL SyrGCSP20µl)	●	○
	PAL SyrGCSP80µl	Kit Dilutor Syringe 80µl for PAL Combi- xt consisting of: 1 pc sideport syringe plunger sealing screw 1 pc sideport syringe adapter 1 pc sideport syringe plunger holder 1 pc sideport syringe 80µl SYRC SP80-R 3 pcs Ndl S-26-AS needles gauge 26	●	○
	PAL SyrGCSP20µl	Kit Dilutor Syringe 20µl for PAL Combi- xt consisting of: 1 pc sideport syringe plunger sealing screw 1 pc sideport syringe adapter 1 pc sideport syringe plunger holder 1 pc sideport syringe 20µl SYRC SP20-R 3 pcs Ndl S-26S-AS needles gauge 26S	●	○

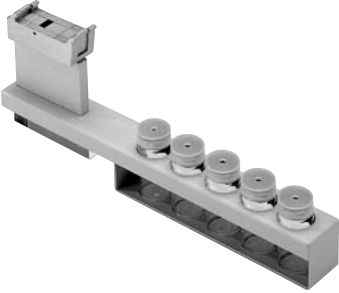

Dilutor Syringes and Plungers





SYRC DIL1.0	PAL Dilutor Syringe 1ml	●	○
SYRC DIL2.5	PAL Dilutor Syringe 2.5ml	●	○
SYRC DIL5.0	PAL Dilutor Syringe 5ml	●	○
SYRC DIL10	PAL Dilutor Syringe 10ml	●	○
SYRC SP80-R	Sideport syringe 80µl gastight without needle	●	○
SYRC SP20-R	Sideport syringe 20µl gastight without needle	●	○
Ndl S-26-AS	3 pcs replacement needle gauge 26 pointstyle AS sideport syringe 80µl	●	○
Ndl S-26S-AS	3 pcs replacement needle gauge 26S pointstyle AS sideport Syringe 20µl	●	○
PLG SP80	10 pcs replacement syringe plunger for 80µl sideport syringe	●	○
PLG SP20	10 pcs replacement syringe plunger for 20µl sideport syringe	●	○
1000-SV	1 pc Dilutor Solvent bottle 1000ml	●	○
PAL DIL 1.0	Replacement plunger for dilutor syringe 1.0ml	●	○
PAL DIL 2.5	Replacement plunger for dilutor syringe 2.5ml	●	○
PAL DIL 5.0	Replacement plunger for dilutor syringe 5.0ml	●	○
PAL DIL 10	Replacement plunger for dilutor syringe 10ml	●	○

PAL Accessory	Part Number	Description	Combi-xt	GC-xt
Flow Cell 	PAL FlowCell	Flow-Through Cell consisting of: 1 pc Flow-Cell, Stainless Steel type 316 2 pcs Stainless Steel connectors Swagelok 1/4 inch 1 pc holder 88mm 5 pcs inlet septa, ø10mm	•	•
Wash Station 	PAL WashStd1	Wash Station for two solvents, consisting of: 1 pc vial holder for 5 vials 10ml 5 pcs vials 10ml 5 pcs caps and seals	•	•
Kit Seal Cap 	Kit SealCap	10 caps and 10 seals for 100-WV solvent bottle or PAL WashStd1 solvent vials	•	•
Kit Wash 	KitWash-10CV	10 pcs solvent vials 10ml 10 pcs caps 10 pcs seals for PAL WashStd1	•	•



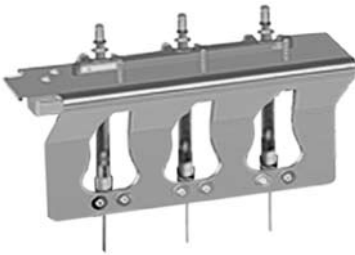

PAL Accessory	Part Number	Description	Combi-xt	GC-xt
Large Volume Wash Station 	PAL WashLarge	LC PAL Wash Station for two solvents, consisting of: 1 pc vial holder for 2 x 100ml vials 2 pcs vials 100ml, including caps and seals 1 pcs waste port including cap, septa, and waste tubing	●	●
	100-WV	100ml solvent bottle for PAL WashLarge	●	●
	Kit SealCap	10 caps and 10 seals for 100-WV solvent bottle or PAL WashStd1 solvent vials	●	●
Solvent Reservoir 	PAL 3xSolv100	Solvent reservoir consisting of: 1 pc holder for 3pc 100ml vials 3 pcs solvent vials 100ml including caps and seals	●	●
	100-WV	100ml solvent bottle for LC PAL Wash Station PAL WashLarge or PAL 3xSolv 100 solvent reservoir including cap and seal	●	●
	Kit SealCap	10 caps and 10 seals for 100-WV solvent bottle or LC PAL Waste port	●	●
SPME Upgrade 	PAL SPMEOpt	SPME option for PAL Combi- xt consisting of: 1 pc SPME fiber holder 1 pc fiber assortment kit 1 pc SPME holder adapter 1 pc plunger holder 1 pc SPME Option operating manual	●	○
SPME Fiber Conditioning Station 	PAL FibCond	SPME Fiber Conditioning Station consisting of: 1 pc heater up to 350°C with connection cable and bracket 40mm 1 pc flush gas connection 1 pc fitting for CombiPAL flush gas regulator 1 pc tubing kit 1 pc alternate bracket 14mm	●	○

PAL Accessory	Part Number	Description	Combi-xt	GC-xt
ITEX-2 Option 	PAL ITEX-2Option	ITEX-2 Option for PAL Combi- xt consisting of: 1 pc 1.3 ml ITEX syringe with M7 x 0.5 fitting 1 pc replacement plunger 1.3 ml 2 pcs ITEX-2 trap TENAX TA 80/100 mesh incl. O - Ring 1 pc trap heater incl. electrical connections 1 pc syringe heater incl. plunger holder 1 pc syringe heater side bracket 1 pc CD Rom with ITEX software (requires PAL LHS2 and Cycle Composer)	●	○
	ITEX-2TrapTXTA ITEX-2TrapTXTA3 SYRC ITEX-2-1.3 PLG ITEX-2-1.3	1 pc ITEX-2 Trap Tenax TA 80/100 mesh Set of 3 pcs ITEX-2 Trap Tenax TA 80/100 mesh ITEX-2 syringe 1.3ml with adapter M7x0.5 Replacement plunger for ITEX-2 syringe	● ● ● ●	○ ○ ○ ○
	ITEX Option (previous version) Consumables/Spares	ITEXTrapTXTA ITEXTrapTXTA3 SYRC ITEX2.5	1 pc ITEX Trap Tenax TA 80/100 mesh Set of 3pcs ITEX Trap Tenax TA 80/100 mesh 1 pc replacement ITEX Syringe 2.5ml	● ● ●
Headspace Upgrade Kit 	PAL LHSUpgrd	Headspace Upgrade for LHS0 PAL Combi- xt Liquid only version consisting of: 1 pc incubator for 2ml/10ml/20ml vials shaker, temperature up to 200°C 1 pc syringe heater 2.5ml 2 pcs headspace syringes 2.5ml SYRC HS 2.5-23-5 1 pc PAL TraySet20ml Tray for 32 vials 10/20ml including holder 114mm 1 pc pressure regulator 1 pc magnetic transport ring 1 pc vial transport teaching kit 6 pcs adaptor to use 10ml vials 1 pc CD ROM with HS Software Upgrade (for model PAL LHS0)	●	○
	PAL Ins20/2ml	6 pcs 2ml inserts to use 2ml vials in PAL Incub6x20	●	○
COMBI-xt & GC-xt Upgrade Kit 	Kit Combi- xt	Kit xt Upgrade for PAL Combi- xt Systems 1 pc control board- xt for PAL System - Firmware 4.X 1 pc side cover with gas flush valve for PAL Combi- xt 1 pc back cover (for 80cm standard rail version) including screws 1 pc Aux cable (Cbl RS20R-1300) 1 pc LAN Cable (3m) 1 pc system CD ROM for xt - Systems 1 pc manual xt -Upgrade	○	○
	Kit GC- xt	Kit xt Upgrade for PAL GC- xt Systems 1 pc control board- xt for PAL System – Firmware 4.X 1 pc back cover (for 80cm standard rail version) including screws 1 pc LAN Cable (3m) 1 pc system CD ROM for xt - Systems 1 pc manual xt -Upgrade	○	○

PAL GC Accessories

PAL Accessory	Part Number	Description	Combi- <i>xt</i>	GC- <i>xt</i>
MHE Tool 	PAL MHETool	MHE Option for PAL Combi- <i>xt</i> , consisting of: 1 pc MHE tool 1 pc MHE parkstation 1 pc needle MHE gauge 22/5 1 pc MHE tool CD (Firmware 3.X backup file) 1 pc manual MHE Option (requires PAL LHS2)	●	○
PAL Exchange 	PAL XCHANGEOpt	PAL XCHANGE® Option for PAL- <i>xt</i> Systems consisting of: 1 pc XCHANGE® park station 1 pc plunger coupling 1 pc XCHANGE® coupling 1 pc safety guard 1 pc active needle guide 1 pc set of XCHANGE® syringes 1 pc PAL- <i>xt</i> System CD (requires PAL Firmware 4.X, for PAL- <i>xt</i> Systems only)	●	○
GC Mounting Kits 	PAL-MR-5890	Mounting hardware for Agilent GC 5890	●	●
	PAL MR-6850	Mounting hardware for Agilent GC 6850	●	●
	PAL MR 6850-Dual	MR-6850 add-on to align 2 Agilent 6850 GC's	●	●
	PAL MR-7890 - <i>xt</i>	Mounting hardware for Agilent GC 6890 or GC 7890	●	●
	PAL MR-TRACE-OC - <i>xt</i>	Mounting hardware for Thermo Trace 2000 (150mm legs, for Thermo On-column Injector only) (requires Kit Trace-OC)	●	●
	PAL MR-TRACE-SSL - <i>xt</i>	Mounting hardware for Thermo Trace 2000 (215mm legs, for Thermo Split/Splitless and PTV Injector)	●	●
	PAL MR-Focus - <i>xt</i>	Mounting hardware for Thermo GC Focus	●	●
	PAL MR-V3900/V43X- <i>xt</i>	Mounting hardware for Varian GC 3900 / 43X-GC	●	●
	PAL MR-V3800/V450 - <i>xt</i>	Mounting hardware for Varian GC 3800 / 450-GC	●	●
	PAL MR-V3400/3600	Mounting hardware for Varian GC 3400 / GC 3600	●	●
	PAL MR-S2014 - <i>xt</i>	Mounting hardware for Shimadzu GC 2014	●	●
	PAL MR-S2010 - <i>xt</i>	Mounting hardware for Shimadzu GC 2010	●	●
	PAL MR-S17A	Mounting hardware for Shimadzu GC 17A	●	●
	PAL MR-S14B	Mounting hardware for Shimadzu GC 14B	●	●
	PAL MR-PEXL	Mounting hardware for Perkin Elmer GC Autosystem XL or Perkin Elmer GC Clarus 500	●	●
	PAL MR-PEC600 - <i>xt</i>	Mounting hardware for Perkin Elmer GC Clarus 600	●	●
	PAL MR-GC353/390	Mounting hardware for GL Sciences GC353/390	●	●
	PAL MR-Std - <i>xt</i>	2pcs standard support 215mm for GC1, LHS0 or LHS2	●	●

PAL GC Accessories

PAL Accessory	Part Number	Description	Combi-xt	GC-xt
Barcode Reader 	PAL BCReader	Barcode Reader Laser scanner for barcode labels on 2/10/20ml vials including electrical connection cable	•	•
Software and Drivers 	PAL CycCompCD	Cycle Composer remote control software for PAL System CD ROM consisting of: Cycle Composer standalone version 1 PAL Driver for Agilent ChemStation data system PAL Driver for Thermo Xcalibur data system (requires PAL Firmware 2.2.0 or higher and Win 2000/XP or higher)	•	•
	PAL CycCompCD5	Cycle Composer remote control software for PAL System CD ROM, site license for 5 instruments consisting of: Cycle Composer standalone version including 5 serial numbers PAL Driver for Agilent ChemStation data system PAL Driver for Thermo Xcalibur data system (requires PAL Firmware 2.2.0 or higher and Win 2000/XP or higher)	•	•
	PAL CycEdit	PAL Cycle Editor license	•	•
	PAL ICC-CE	CTC Instrument control components including Cycle Editor	•	•
	PAL DrvEmp	PAL Driver for Waters Empower	•	•
Instrument Qualification 	PAL GC-QDoc	Instrument Qualification for PAL Combi- xt and PAL GC- xt consisting of: 1 pc Log Book 1 pc Documentation IQ procedure 1 pc Documentation OQ procedure	•	•
	PAL GC-ReQ	Instrument Requalification for PAL Combi- xt and PAL GC- xt consisting of: 1 pc Documentation OQ procedure	•	•
Toolkit 	PAL Toolkit	Torx driver set for PAL System	•	•