



PAL LSI - Robust and Reliable Sample Handling



The PAL System, ingeniously reliable,
flexible and productive

PAL LSI: Innovative features giving real benefits

Easy maintenance and adaptation: The different syringes available (1.2 / 5 / 10 / 25 and 100 μ L) can readily be exchanged within seconds.

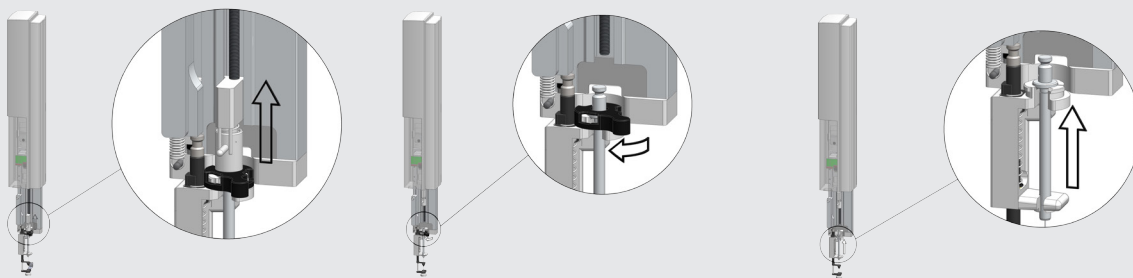

Large Sample Capacity: 162 x 2 mL-vials can be stored on one tray holder. The standard length PAL LSI can hold 648 x 2 mL-vials on four Tray Holders. With the optional Peltier stack samples can be stored at a controlled temperature.

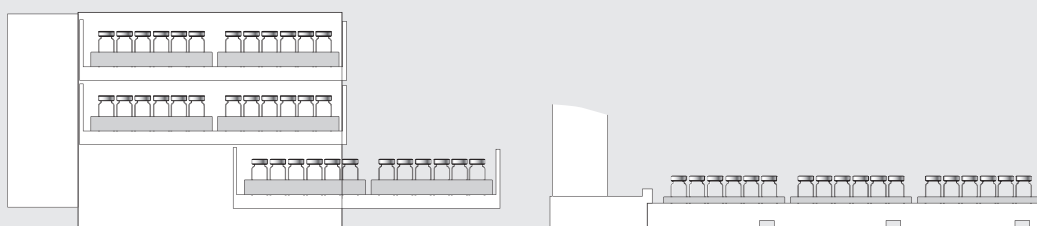

Process safety: Proprietary drive technology enables the detection of missing vials and the correct position of the syringe needle in the injector port. Bending of syringe needles is excluded.

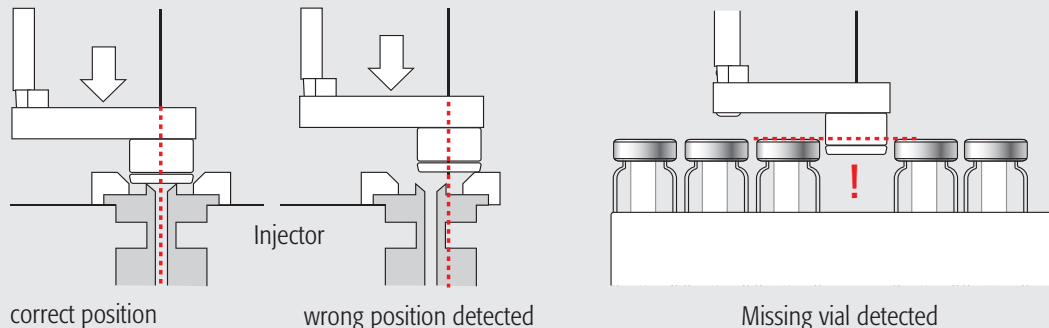

Ultrafast injections: Injections down to 100 ms reduce discrimination in GC down to $C_{40}/C_{20} > 0.98$.

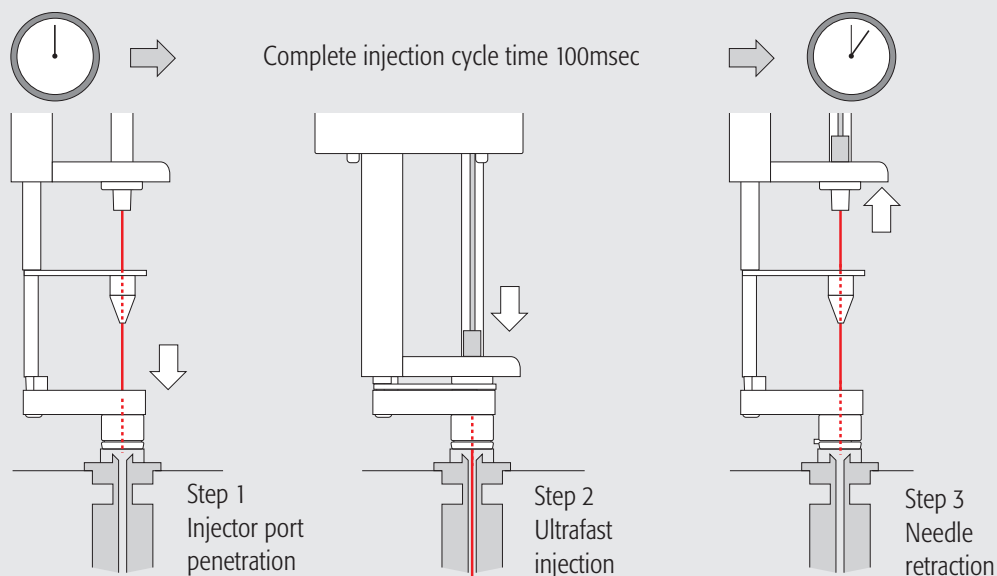

Perfect injection handling gives reproducible results

Only perfect injection handling gives reproducible results.

The PAL LSI is designed for the precise and accurate handling of liquid and gaseous samples of up to 100 μL in volume. In combination with the PAL Sample Control software all parameters of aspirating and dispensing of liquid samples can be fully controlled. This is crucial for perfect injections.

A range of syringes from 1.2 μL to 100 μL is available.

In the examples highlighted here an aliquot of an internal standard is sandwiched between transport solvent and the sample. Air gaps in between the liquids preclude mixing of the different liquids. The accurate control of these steps is the basis of reproducible methods.

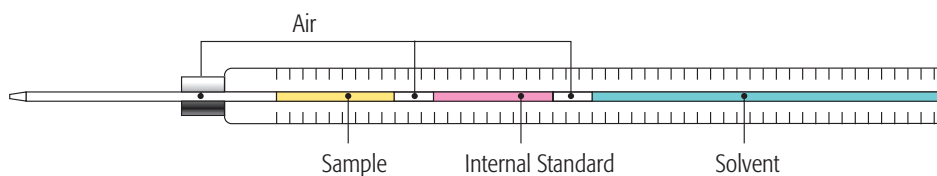

Pick and Place

The PAL LSI is a robot that can reach any three dimensional position within its working space and is ideally suited to pick and place objects like vials. It can inject from several sample containers into different detectors or transport vials from a tray to a temperature controlled stack.





Configure your PAL
for the jobs you want done

Flexibility: A wide range of accessories for the PAL LSI

Available **syringes** are 1.2 / 5 / 10 / 25 and 100 μ L.



Additional Tray Holders increase the **sample capacity**. Supported vial formats are 1, 2, 10 and 20 mL, as well as 96 / 384 well micro titer plates and deep well plates. Up to 648 x 2 mL vials or 12 MTPs can be stored.



Temperature controlled Peltier stacks for 2 or 6 sample trays or plates can be added to prevent degradation or to heat samples for derivatization reactions or kinetic studies.



The Standard Wash Module is ideal for **washing the syringe with up to four different solvents** (4 x 10 mL solvent vial, 1 x 10 mL waste vial). An optional waste tube is available.



The Fast Wash Module is preferred when **low carry-over** is required. It also cleans syringes incl. the outside of the needle (gauge 19-26) with 2 different solvents.



The Solvent Module allows **adding liquids** (with three 100 mL solvent containers)



The Vortex Mixer Module offers **efficient mixing** for dilution / extraction.

- Standard vial sizes: 2 mL / 10 mL / 20 mL
- 1 additional slot for custom specific vials
- Provides efficient mixing with up to 2000 rpm



The Barcode Reader Module is used to **read horizontal 1D barcodes labels** on 2 mL, 10 mL and 20 mL vials. The two scanners allow the identification of vials irrespective of the position of the barcode on the vials. Therefore it ensures highest process safety and traceability.



With the Valve Drive Module **different injection or switching valves** can be configured. A wide variety of different valve types can be used.



Ingenious Master Software



PAL Sample Control

Easy to use routine software

PAL Sample Control software is the user-friendly tool for the daily routine jobs. A few clicks and sample lists are generated or imported. Now PAL Sample Control starts the operation and the data acquisition. Since PAL Sample Control interfaces seamlessly with major chromatographic or MS data systems only one sample list has to be handled. Different user levels ensure process safety.

Productivity

PAL Sample Control allows overlapping of multiple sample procedures. It optimizes automatically the timing of various steps in a sample preparation process and generates a schedule that minimizes the runtimes of sequences. This increases sample throughput greatly and boosts productivity.

Powerful Method Editor

While PAL Sample Control is straightforward to use in the daily operations it is also a powerful tool for the generation of tailored methods. A set of tested methods that comes with every system (e.g. partial loop liquid injection) can be used as templates and optimized or tailored for specific workflows. Furthermore a large number of building blocks (tasks) for method development are part of the software. These building blocks make it easy to generate new methods, even for complex workflows.

PAL Sample Control is the common platform for PAL RTC, RSI, and LSI, and is shipped with every PAL LSI.

Supported CDS and MS-Data Systems

- Analyst
- ChemStation LC/GC/MSD
- Chromcard
- ChromPerfect
- ChromQuest
- Clarity
- Empower 2
- EZChrom
- MassHunter GC/MS, LC/MS
- Master Lab
- QuanLab
- Xcalibur

Dimensions

	PAL LSI compact x-axis length	PAL LSI standard x-axis length
Working Space	Width: 420 mm (16.8 inches) Depth: 255 mm (10.0 inches) Height: 420 mm (16.8 inches)	Width: 735 mm (28.9 inches) Depth: 255 mm (10.0 inches) Height: 420 mm (16.8 inches)
Footprint Instrument dimensions with standard legs	Width: 600 mm (24.0 inches) Depth: 795 mm (31.8 inches) Height: 770 mm (30.8 inches)	Width: 915 mm (36.6 inches) Depth: 795 mm (31.8 inches) Height: 770 mm (30.8 inches)

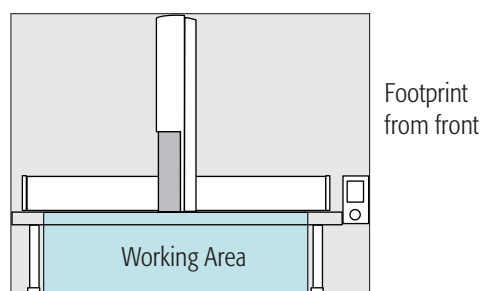
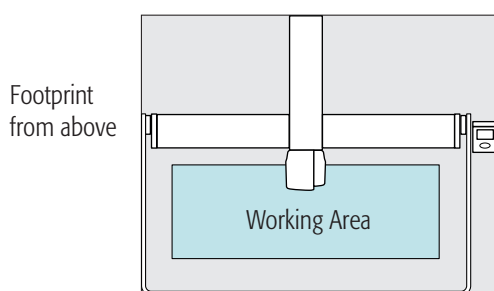

Sample Capacity	2 Tray Holders Up to 420 x 1 mL vials 324 x 2 mL vials 90 x 10 / 20 mL vials 6 x MT/DW plates	4 Tray Holders Up to 840 x 1 mL vials 648 x 2 mL vials 180 x 10 / 20 mL vials 12 x MT/DW plates
-----------------	---	---

Application Specifications*

Type	Specifications	Comment
Injection volume	0.1 - 100 μ L	Depending on syringe, available syringes are 1.2 / 5 / 10 / 25 and 100 μ L, needle length 57 mm
LC Liquid injection, repeatability (UV)	Full loop < 0.1 % RSD Partial loop < 0.15 % RSD	20 μ L loop, 4 x overfill, 100 μ L syringe 10 μ L in 20 μ L loop, 100 μ L syringe
LC Liquid injection, linearity (gravimetric)	R > 0.9999	20, 40, 60, 80, 100 μ L, n=3 each level
LC Carry-over	< 200 ppm	with Fast Wash Station, 100 μ L X-type G22 syringe blank measured after injection of Cl-Hexidine 0.6 mg/mL
GC liquid injection, repeatability	< 0.60 % RSD	Alkanes C14, C15, C16, 1 μ L, split mode
GC liquid injection, linearity (gravimetric)	R > 0.9999	20, 40, 60, 80, 100 μ L, n=3 each level
GC needle discrimination	C40 / C20 > 0.98	Restek Florida Mix 1 μ L, 100 ms fast split/splitless injection

*Detailed conditions for the determination of specifications upon request



Distributed by:

The PAL System is one of the most widely used and successful sample preparation and handling platforms.

- 40'000 systems worldwide are proof of the PAL Systems' reliability and flexibility. PAL Systems are developed and manufactured under an ISO 9001 / 13485 quality management system. After careful assembly every PAL System has passed a 24h performance test before leaving the factory.
- The PAL LSI is an economical system designed for the accurate and precise handling of gaseous and liquid samples.
- The PAL LSI can move objects, like vials from and to any position within its working range.
- The PAL LSI is available as compact or standard sized system.
- The PAL LSI, like all members of the PAL family it can be upgraded should the need arise for more functionality or sample capacity.

For more information on the PAL LSI visit:

www.palsystem.com



PAL is a registered trademark of CTC Analytics AG, Switzerland